

NET-FMC

UserManual

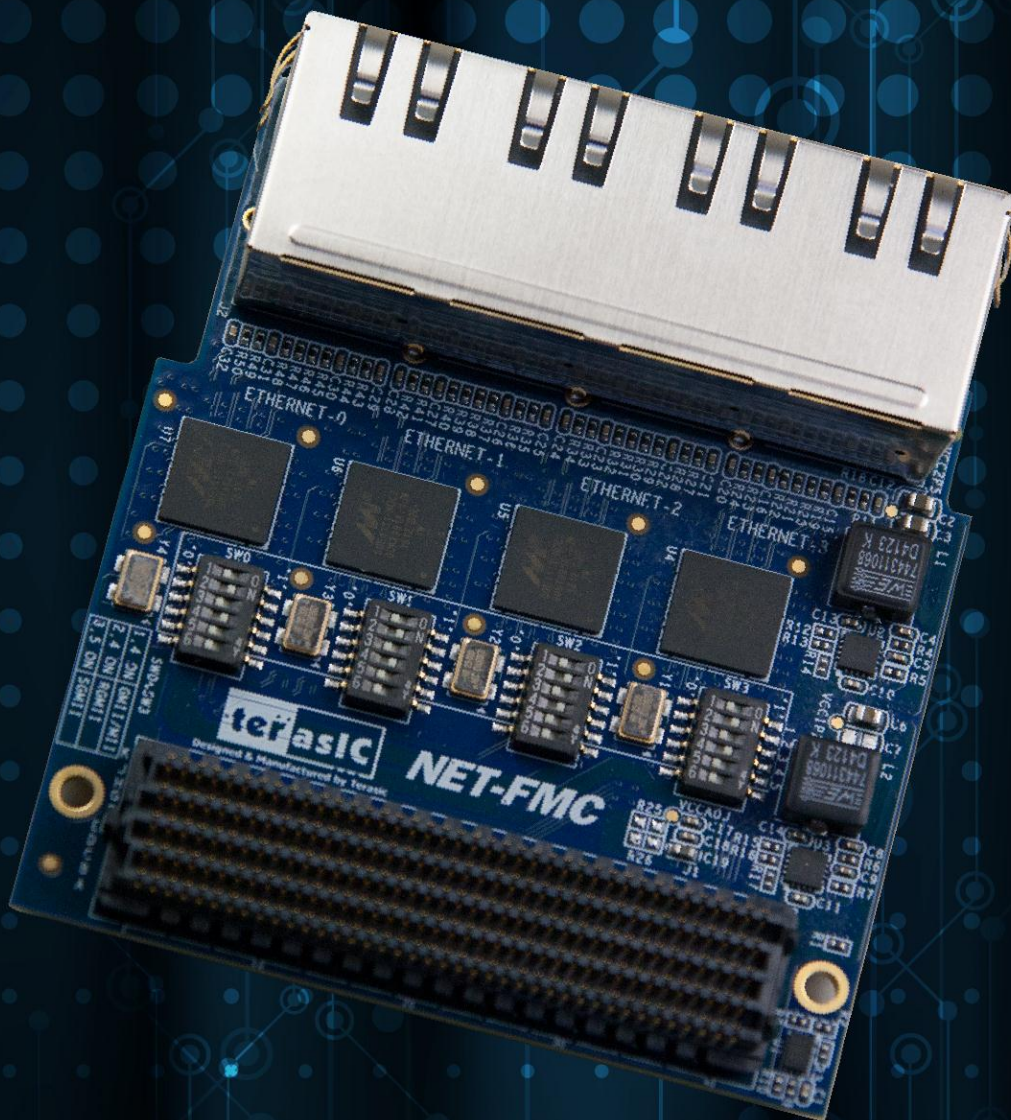

terasic
www.terasic.com

Copyright © 2003-2017 Terasic Inc. All Rights Reserved.

目錄
ter

asic

NET-FMC CONTENT

CHAPTER 1	NET-FMC DEVELOPMENT KIT	- 1 -
1-1 PACKAGE CONTENTS		- 1 -
1-2 NET-FMC SYSTEM CD		- 1 -
1-3 GETTING HELP		- 1 -
CHAPTER 2	INTRODUCTION OF THE NET-FMC CARD	- 2 -
2-1 FEATURES		- 3 -
2-2 BLOCK DIAGRAM OF THE NET-FMC BOARD.....		- 3 -
2-3 CONNECTIVITY		- 5 -
CHAPTER 3	USING THE NET-FMC BOARD	- 6 -
3-1 ETHERNET PHY 88E1111.....		- 6 -
3-2 FMC CONNECTOR.....		- 7 -
CHAPTER 4	EXAMPLE CODES	- 13 -
4-1 REMOTE UPDATE PORTAL.....		- 13 -
CHAPTER 5	APPENDIX	- 22 -

Chapter 1

NET-FMC Development Kit

1-1 Package Contents

The Terasic NET-FMC is a Gigabit Ethernet transceiver with an FMC interface. It offers network transfers of up to 1 Gbps with the host board using an FMC connector. Also, it provides a fully integrated Ethernet solution enabling fast implementation design, shortening development times, and allows you to focus on the core functions of the system design. Lastly, the NET-FMC can be connected any FMC(HPC) interfaces.



Figure 1-1 The NET-FMC package contents

1-2 NET-FMC System CD

The NET-FMC System CD contains all the documents and supporting materials associated with NET-FMC, including the user manual, reference designs, and device datasheets. Users can download this system CD from the link: <http://net-fmc.terasic.com/cd>

1-3 Getting Help

Here are the addresses where you can get help if you encounter any problems:

Terasic Technologies

9F., No.176, Sec.2, Gongdao 5th Rd, East Dist, Hsinchu City, 30070. Taiwan

Email: support@terasic.com

Tel.: +886-3-575-0880

Website: <http://www.terasic.com>

Chapter 2

Introduction of the NET-FMC Card

This chapter describes the architecture and configuration of the NET-FMC Board including block diagram and components related.

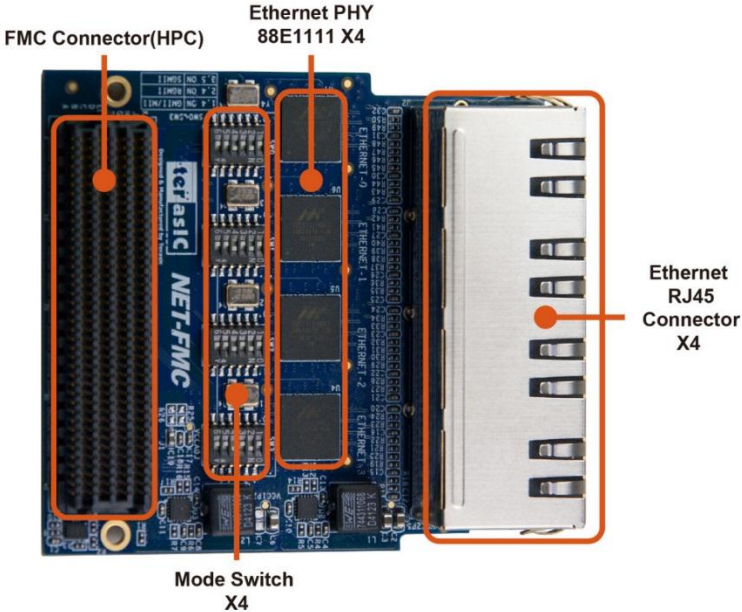

Figure 2-1 The NET-FMC Board PCB and Component Diagram of top side

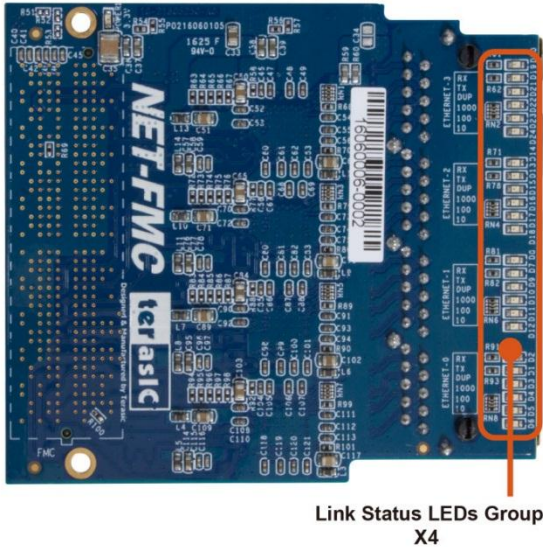

Figure 2-2 The NET-FMC Board PCB and Component Diagram of bottom side

The photographs of the NET-FMC are shown in [Figure 2-1](#) and [Figure 2-2](#). They depict the layout of the board and indicates the location of the connectors and the key components on the top and bottom side.

The following components are provided on the NET-FMC Board:



- Ethernet RJ45 Connector x4.
- Ethernet PHY chip 88E1111 x4.
- FMC Connector(HPC).
- Mode Switch x4.
- Link Status LEDs Group x4.

2-1 Features

The NET-FMC board has many features that allow users to implement a wide range of design circuits, from simple circuits to various multimedia projects.

The following hardware is provided on the board:

- Package Interface: VITA 57.1 FMC, 2.5V I/O-standard.
- Ethernet PHY module:
 - Chip P/N: 88E1111.
 - 10/100/1000BASE-T IEEE 802.3 compliant.
 - Support MAC Interface: GMII/MII, RGMII, SGMII.
- Ethernet RJ45 Connector x4:
 - Use standard Cat 5 UTP cabling.
- Mode Switch :
 - Support GMII/MII, RGMII, SGMII.
- Four 25-MHz reference clock driven from dedicated oscillator.

2-2 Block Diagram of the NET-FMC Board

Figure 2-3 shows the NET-FMC Block Diagram. Four 25 MHz reference clock driven from dedicated oscillator are required for Ethernet PHY 88E1111. FMC Connector transmit the data between host board and Ethernet PHY 88E1111 through MAC interface. Also, four-port integrated 10/100/1000 Gigabit Ethernet Transceiver supported SGMII/GMII/MII/RGMII MAC interfaces is installed for direct connection to a MAC/Switch port. There are four group LEDs indicting the link status.

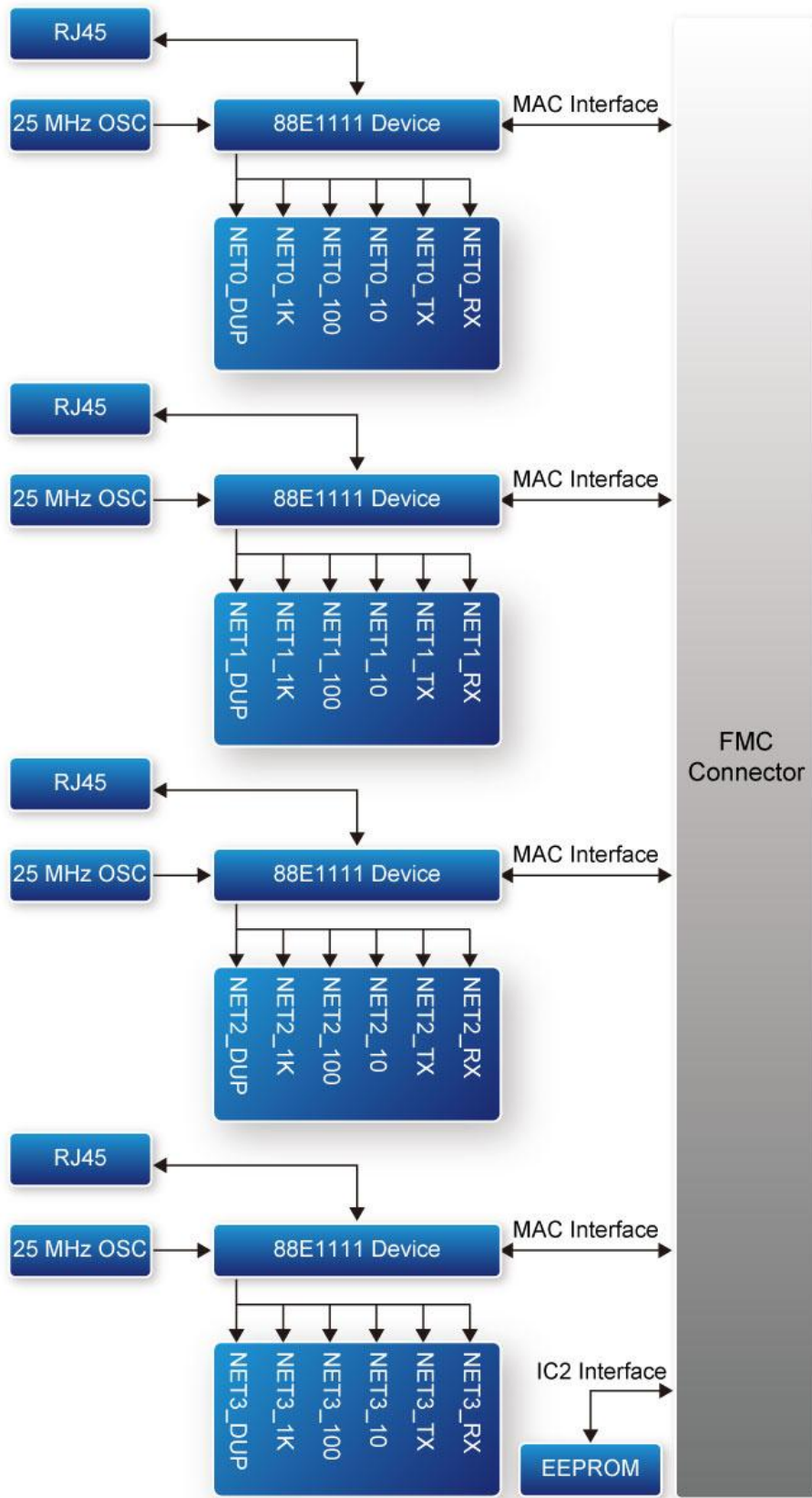

Figure 2-3 Block Diagram of NET-FMC Board

2-3 Connectivity

Terasic NET-FMC is able to connect to any FPGA development kit equipped with FMC(HPC) connector. The below picture **Figure 2-4** shows the connections with TR5 board.

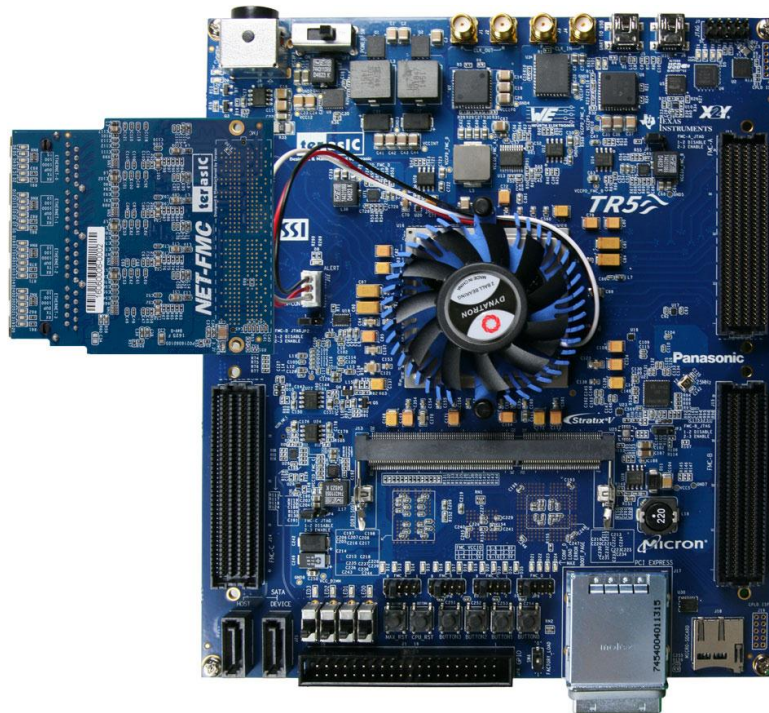

Figure 2-4 Connect the NET-FMC to TR5 board's FMCD port

Chapter 3

Using the NET-FMC Board

This chapter provides instructions on how to use Ethernet PHY 88E1111 and FMC connector on the HDMI-FMC board.

3-1 Ethernet PHY 88E1111

Terasic NET-FMC Board equips with four Ethernet PHY named 88E1111, which is an integrated 10/100/1000 ultra gigabit Ethernet transceiver device for Ethernet 10BASE-T, 100BASE-TX and 1000BASE-T applications. It contains all the active circuitry required to implement the physical layer functions to transmit and receive data on standard CAT 5 unshielded twisted pair. The 88E1111 device supports the Gigabit Media Independent Interface (GMII/MII), Reduced GMII (RGMII), and Serial Gigabit Media Independent Interface (SGMII) for direct connection to a MAC/Switch port.

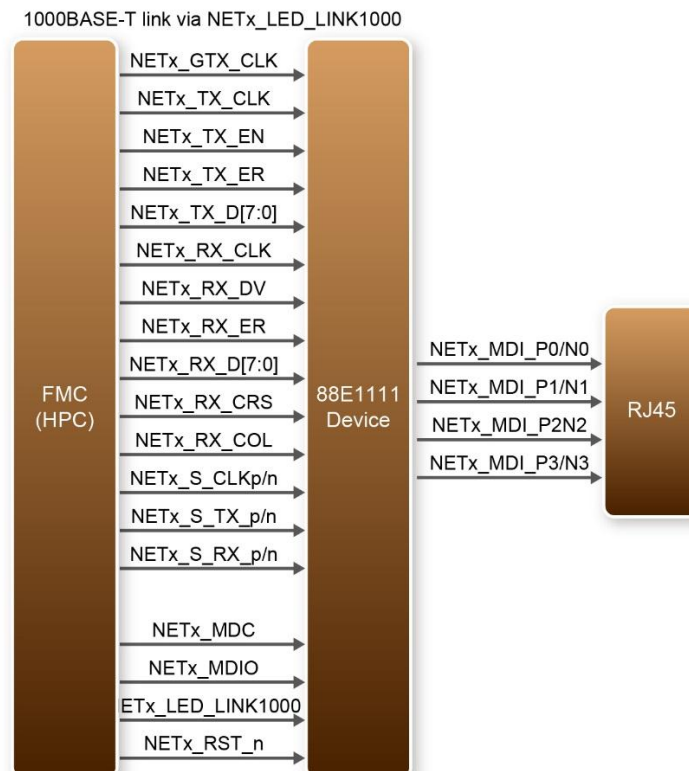

Figure 3-1 System Overview with 88E1111 device

Figure 3-1 shows the connections between the FMC (HPC), the 88E1111 Ethernet PHY, and RJ-45 connector. Ethernet PHY 88E1111 function are controlled by the management

interface via NETx_MDC and NETx_MDIO. There is a LED used to indicate the status of 1000BASE-T link via NETx_LED_LINK1000.

The 88E1111 device incorporates the Marvell Virtual Cable Tester(VCT) feature, which uses Time Domain Reflectometry(TDR) technology for the remote identification of potential cable malfunctions, thus reducing equipment returns and service calls. Using VCT, the 88E1111 device detects and reports potential cabling issues such as pair swaps, pair polarity and excessive pair skew.

The 88E1111 device uses advanced mixed-signal processing to perform equalization, echo and crosstalk cancellation, data recovery, and error correction at a gigabit per second data rate. The device achieves robust performance in noisy environments with very low power dissipation.

3-2 FMC Connector

Table 3-1 shows the pin out and pin definitions of NET-FMC board.

Table 3-1 Pin Assignment of NET-FMC FMC interface

Signal Name	FMC Pin Name/Number	Pin Direction	Description	I/O Standard
NET0_GTX_CLK	LA01_P_CC/D8	Output	Ethernet-0 GMII/TBI Transmit Clock	2.5V
NET0_TX_CLK	HA11_P/J12	Input	Ethernet-0 MII Transmit Clock, TBI 62.5 MHz Receive Clock 1	2.5V
NET0_TX_EN	LA08_P/G12	Output	Ethernet-0 GMII/MII Transmit Enable, TBI Transmit Data 8	2.5V
NET0_TX_ER	HA14_P/J15	Output	Ethernet-0 GMII/MII Transmit Error, TBI Transmit Data 9	2.5V
NET0_TX_D[0]	LA08_N/G13	Output	Ethernet-0 GMII/MII/TBI Transmit Data 0	2.5V
NET0_TX_D[1]	LA04_P/H10	Output	Ethernet-0 GMII/MII/TBI Transmit Data 1	2.5V
NET0_TX_D[2]	LA03_N/G10	Output	Ethernet-0 GMII/MII/TBI Transmit Data 2	2.5V
NET0_TX_D[3]	LA13_P/D17	Output	Ethernet-0 GMII/MII/TBI Transmit Data 3	2.5V
NET0_TX_D[4]	HA20_N/E19	Output	Ethernet-0 GMII/TBI Transmit Data 4	2.5V
NET0_TX_D[5]	HB03_N/E22	Output	Ethernet-0 GMII/TBI Transmit Data 5	2.5V
NET0_TX_D[6]	HB03_P/E21	Output	Ethernet-0 GMII/TBI Transmit Data 6	2.5V
NET0_TX_D[7]	HB05_P/E24	Output	Ethernet-0 GMII/TBI Transmit Data 7	2.5V
NET0_RX_CLK	LA13_N/D18	Input	Ethernet-0 GMII/MII Receive Clock, TBI 62.5 MHz Receive Clock 0	2.5V
NET0_RX_DV	LA05_N/D12	Input	Ethernet-0 GMII/MII Receive Valid, TBI Transmit Data 8	2.5V

NET0_RX_ER	HA20_P/E18	Input	Ethernet-0 GMII/MII Receive Error, TBI Transmit Data 9	2.5V
NET0_RX_D[0]	LA06_N/C11	Input	Ethernet-0 GMII/MII/TBI Receive Data 0	2.5V
NET0_RX_D[1]	LA05_P/D11	Input	Ethernet-0 GMII/MII/TBI Receive Data 1	2.5V
NET0_RX_D[2]	LA04_N/H11	Input	Ethernet-0 GMII/MII/TBI Receive Data 2	2.5V
NET0_RX_D[3]	LA06_P/C10	Input	Ethernet-0 GMII/MII/TBI Receive Data 3	2.5V
NET0_RX_D[4]	HA00_N_CC/F5	Input	Ethernet-0 GMII/TBI Receive Data 4	2.5V
NET0_RX_D[5]	HA07_P/J9	Input	Ethernet-0 GMII/TBI Receive Data 5	2.5V
NET0_RX_D[6]	HA03_P/J6	Input	Ethernet-0 GMII/TBI Receive Data 6	2.5V
NET0_RX_D[7]	HA00_P_CC/F4	Input	Ethernet-0 GMII/TBI Receive Data 7	2.5V
NET0_RX_CRS	CLK3_BIDIR_P/J2	Input	Ethernet-0 GMII/MII Carrier Sense, TBI Valid Comma Detect	2.5V
NET0_RX_COL	CLK3_BIDIR_N/J3	Input	Ethernet-0 GMII/MII Collision, TBI Mode Loopback	2.5V
NET0_S_CLKp	LA00_P_CC/G6	Input	Ethernet-0 SGMII 625 MHz Receive Clock	2.5V
NET0_S_CLKn	LA00_N_CC/G7	Input		
NET0_S_TX_p	HA04_P/F7	Output	Ethernet-0 SGMII Transmit Data	2.5V
NET0_S_TX_n	HA04_N/F8	Output		
NET0_S_RX_p	HA05_P/E6	Input	Ethernet-0 SGMII Receive Data	2.5V
NET0_S_RX_n	HA05_N/E7	Input		
NET0_MDC	LA03_P/G9	Output	Ethernet-0 Management Reference Clock	2.5V
NET0_MDIO	LA02_N/H8	Inout	Ethernet-0 Management Data	2.5V
NET0_INT_n	CLK0_M2C_P	Input	Ethernet-0 Interrupt	2.5V
NET0_LED_LIN K1000	HA02_P/K7	Input	Ethernet-0 Parallel LED output for 1000BASE-T link/speed or link indicator	2.5V
NET0_RST_n	LA02_P/H7	Output	Ethernet-0 Hardware Reset, active low	2.5V
NET1_GTX_CLK	LA01_N_CC/D9	Output	Ethernet-1 GMII/TBI Transmit Clock	2.5V
NET1_TX_CLK	HA19_N/F20	Input	Ethernet-1 MII Transmit Clock, TBI 62.5 MHz Receive Clock 1	2.5V
NET1_TX_EN	LA14_P/C18	Output	Ethernet-1 GMII/MII Transmit Enable, TBI Transmit Data 8	2.5V
NET1_TX_ER	HB02_P/F22	Output	Ethernet-1 GMII/MII Transmit Error, TBI Transmit Data 9	2.5V
NET1_TX_D[0]	LA14_N/C19	Output	Ethernet-1 GMII/MII/TBI Transmit Data 0	2.5V
NET1_TX_D[1]	LA17_P_CC/D20	Output	Ethernet-1 GMII/MII/TBI Transmit Data 1	2.5V
NET1_TX_D[2]	LA17_N_CC/D21	Output	Ethernet-1 GMII/MII/TBI Transmit Data 2	2.5V

NET1_TX_D[3]	LA18_P_CC/C22	Output	Ethernet-1 GMII/MII/TBI Transmit Data 3	2.5V
NET1_TX_D[4]	HB08_P/F28	Output	Ethernet-1 GMII/TBI Transmit Data 4	2.5V
NET1_TX_D[5]	HB07_P/J27	Output	Ethernet-1 GMII/TBI Transmit Data 5	2.5V
NET1_TX_D[6]	HB08_N/F29	Output	Ethernet-1 GMII/TBI Transmit Data 6	2.5V
NET1_TX_D[7]	HB11_P/J30	Output	Ethernet-1 GMII/TBI Transmit Data 7	2.5V
NET1_RX_CLK	LA12_N/G15	Input	Ethernet-1 GMII/MII Receive Clock, TBI 62.5 MHz Receive Clock 0	2.5V
NET1_RX_DV	LA11_N/H17	Input	Ethernet-1 GMII/MII Receive Valid, TBI Transmit Data 8	2.5V
NET1_RX_ER	HA22_P/J21	Input	Ethernet-1 GMII/MII Receive Error, TBI Transmit Data 9	2.5V
NET1_RX_D[0]	LA12_P/G15	Input	Ethernet-1 GMII/MII/TBI Receive Data 0	2.5V
NET1_RX_D[1]	LA11_P/H16	Input	Ethernet-1 GMII/MII/TBI Receive Data 1	2.5V
NET1_RX_D[2]	LA07_N/H14	Input	Ethernet-1 GMII/MII/TBI Receive Data 2	2.5V
NET1_RX_D[3]	LA07_P/H13	Input	Ethernet-1 GMII/MII/TBI Receive Data 3	2.5V
NET1_RX_D[4]	HB04_P/F25	Input	Ethernet-1 GMII/TBI Receive Data 4	2.5V
NET1_RX_D[5]	HB13_P/E30	Input	Ethernet-1 GMII/TBI Receive Data 5	2.5V
NET1_RX_D[6]	HB04_N/F26	Input	Ethernet-1 GMII/TBI Receive Data 6	2.5V
NET1_RX_D[7]	HB09_N/E28	Input	Ethernet-1 GMII/TBI Receive Data 7	2.5V
NET1_RX_CRS	HB05_N/E25	Input	Ethernet-1 GMII/MII Carrier Sense, TBI Valid Comma Detect	2.5V
NET1_RX_COL	HB09_P/E27	Input	Ethernet-1 GMII/MII Collision, TBI Mode Loopback	2.5V
NET1_S_CLKp	CLK1_M2C_P/G 2	Input	Ethernet-1 SGMII 625 MHz Receive Clock	2.5V
NET1_S_CLKn	CLK1_M2C_N/G 3	Input		
NET1_S_TX_p	HA08_P/F10	Output	Ethernet-1 SGMII Transmit Data	2.5V
NET1_S_TX_n	HA08_N/F11	Output		
NET1_S_RX_p	HA09_P/E9	Input	Ethernet-1 SGMII Receive Data	2.5V
NET1_S_RX_n	HA09_N/E10	Input		
NET1_MDC	LA10_N/C15	Output	Ethernet-1 Management Reference Clock	2.5V
NET1_MDIO	LA09_N/D15	Inout	Ethernet-1 Management Data	2.5V
NET1_INT_n	LA10_P/C14	Input	Ethernet-1 Interrupt	2.5V
NET1_LED_LIN K1000	HA02_N/K8	Input	Ethernet-1 Parallel LED output for 1000BASE-T link/speed or link indicator	2.5V

NET1_RST_n	LA09_P/D14	Output	Ethernet-1 Hardware Reset, active low	2.5V
NET2_GTX_CLK	LA16_P/G18	Output	Ethernet-2 GMII/TBI Transmit Clock	2.5V
NET2_TX_CLK	HA18_P/J18	Input	Ethernet-2 MII Transmit Clock, TBI 62.5 MHz Receive Clock 1	2.5V
NET2_TX_EN	LA15_N/H20	Output	Ethernet-2 GMII/MII Transmit Enable, TBI Transmit Data 8	2.5V
NET2_TX_ER	HA19_P/F19	Output	Ethernet-2 GMII/MII Transmit Error, TBI Transmit Data 9	2.5V
NET2_TX_D[0]	LA16_N/G19	Output	Ethernet-2 GMII/MII/TBI Transmit Data 0	2.5V
NET2_TX_D[1]	LA15_P/H19	Output	Ethernet-2 GMII/MII/TBI Transmit Data 1	2.5V
NET2_TX_D[2]	LA20_P/G21	Output	Ethernet-2 GMII/MII/TBI Transmit Data 2	2.5V
NET2_TX_D[3]	LA20_N/G22	Output	Ethernet-2 GMII/MII/TBI Transmit Data 3	2.5V
NET2_TX_D[4]	LA19_P/H22	Output	Ethernet-2 GMII/TBI Transmit Data 4	2.5V
NET2_TX_D[5]	LA19_N/H23	Output	Ethernet-2 GMII/TBI Transmit Data 5	2.5V
NET2_TX_D[6]	HB02_N/F23	Output	Ethernet-2 GMII/TBI Transmit Data 6	2.5V
NET2_TX_D[7]	HB01_P/J24	Output	Ethernet-2 GMII/TBI Transmit Data 7	2.5V
NET2_RX_CLK	LA30_P/H34	Input	Ethernet-2 GMII/MII Receive Clock, TBI 62.5 MHz Receive Clock 0	2.5V
NET2_RX_DV	LA31_P/G33	Input	Ethernet-2 GMII/MII Receive Valid, TBI Transmit Data 8	2.5V
NET2_RX_ER	HB15_P/J33	Input	Ethernet-2 GMII/MII Receive Error, TBI Transmit Data 9	2.5V
NET2_RX_D[0]	LA29_N/G31	Input	Ethernet-2 GMII/MII/TBI Receive Data 0	2.5V
NET2_RX_D[1]	LA28_N/H32	Input	Ethernet-2 GMII/MII/TBI Receive Data 1	2.5V
NET2_RX_D[2]	LA28_P/H31	Input	Ethernet-2 GMII/MII/TBI Receive Data 2	2.5V
NET2_RX_D[3]	LA29_P/G30	Input	Ethernet-2 GMII/MII/TBI Receive Data 3	2.5V
NET2_RX_D[4]	HB12_P/F31	Input	Ethernet-2 GMII/TBI Receive Data 4	2.5V
NET2_RX_D[5]	HB16_P/F34	Input	Ethernet-2 GMII/TBI Receive Data 5	2.5V
NET2_RX_D[6]	HB12_N/F32	Input	Ethernet-2 GMII/TBI Receive Data 6	2.5V
NET2_RX_D[7]	HB19_N/E34	Input	Ethernet-2 GMII/TBI Receive Data 7	2.5V
NET2_RX_CRS	HB13_N/E31	Input	Ethernet-2 GMII/MII Carrier Sense, TBI Valid Comma Detect	2.5V
NET2_RX_COL	HB19_P/E33	Input	Ethernet-2 GMII/MII Collision, TBI Mode Loopback	2.5V
NET2_S_CLKp	HA01_P_CC/E2	Input	Ethernet-2 SGMII 625 MHz Receive Clock	2.5V
NET2_S_CLKn	HA01_N_CC/E3	Input		
NET2_S_TX_p	HA12_P/F13	Output	Ethernet-2 SGMII Transmit Data	2.5V

NET2_S_TX_n	HA12_N/F14	Output		
NET2_S_RX_p	HA13_P/E12	Input	Ethernet-2 SGMII Receive Data	2.5V
NET2_S_RX_n	HA13_N/E13	Input		
NET2_MDC	LA21_N/H26	Output	Ethernet-2 Management Reference Clock	2.5V
NET2_MDIO	LA22_N/G25	Inout	Ethernet-2 Management Data	2.5V
NET2_INT_n	LA21_P/H25	Output	Ethernet-2 Interrupt	2.5V
NET2_LED_LIN K1000	HA06_P/K10	Input	Ethernet-2 Parallel LED output for 1000BASE-T link/speed or link indicator	2.5V
NET2_RST_n	LA22_P/G24	Input	Ethernet-2 Hardware Reset, active low	2.5V
NET3_GTX_CLK	LA30_N/H35	Output	Ethernet-3 GMII/TBI Transmit Clock	2.5V
NET3_TX_CLK	HB16_N/F35	Input	Ethernet-3 MII Transmit Clock, TBI 62.5 MHz Receive Clock 1	2.5V
NET3_TX_EN	LA33_P/G36	Output	Ethernet-3 GMII/MII Transmit Enable, TBI Transmit Data 8	2.5V
NET3_TX_ER	HB18_P/J36	Output	Ethernet-3 GMII/MII Transmit Error, TBI Transmit Data 9	2.5V
NET3_TX_D[0]	LA32_P/H37	Output	Ethernet-3 GMII/MII/TBI Transmit Data 0	2.5V
NET3_TX_D[1]	LA31_N/G34	Output	Ethernet-3 GMII/MII/TBI Transmit Data 1	2.5V
NET3_TX_D[2]	LA33_N/G37	Output	Ethernet-3 GMII/MII/TBI Transmit Data 2	2.5V
NET3_TX_D[3]	LA32_N/H38	Output	Ethernet-3 GMII/MII/TBI Transmit Data 3	2.5V
NET3_TX_D[4]	HA18_N/J19	Output	Ethernet-3 GMII/TBI Transmit Data 4	2.5V
NET3_TX_D[5]	HB01_N/J25	Output	Ethernet-3 GMII/TBI Transmit Data 5	2.5V
NET3_TX_D[6]	HA22_N/J22	Output	Ethernet-3 GMII/TBI Transmit Data 6	2.5V
NET3_TX_D[7]	HB11_N/J31	Output	Ethernet-3 GMII/TBI Transmit Data 7	2.5V
NET3_RX_CLK	LA18_N_CC/C23	Input	Ethernet-3 GMII/MII Receive Clock, TBI 62.5 MHz Receive Clock 0	2.5V
NET3_RX_DV	LA23_N/D24	Input	Ethernet-3 GMII/MII Receive Valid, TBI Transmit Data 8	2.5V
NET3_RX_ER	LA23_P/D23	Input	Ethernet-3 GMII/MII Receive Error, TBI Transmit Data 9	2.5V
NET3_RX_D[0]	LA27_N/C27	Input	Ethernet-3 GMII/MII/TBI Receive Data 0	2.5V
NET3_RX_D[1]	LA27_P/C26	Input	Ethernet-3 GMII/MII/TBI Receive Data 1	2.5V
NET3_RX_D[2]	LA26_P/D26	Input	Ethernet-3 GMII/MII/TBI Receive Data 2	2.5V
NET3_RX_D[3]	LA26_N/D27	Input	Ethernet-3 GMII/MII/TBI Receive Data 3	2.5V
NET3_RX_D[4]	HA07_N/J10	Input	Ethernet-3 GMII/TBI Receive Data 4	2.5V
NET3_RX_D[5]	HA14_N/J16	Input	Ethernet-3 GMII/TBI Receive Data 5	2.5V

NET3_RX_D[6]	HA11_N/J13	Input	Ethernet-3 GMII/TBI Receive Data 6	2.5V
NET3_RX_D[7]	HA03_N/J7	Input	Ethernet-3 GMII/TBI Receive Data 7	2.5V
NET3_RX_CRD	HB20_P/F37	Input	Ethernet-3 GMII/MII Carrier Sense, TBI Valid Comma Detect	2.5V
NET3_RX_COL	HB20_N/F38	Input	Ethernet-3 GMII/MII Collision, TBI Mode Loopback	2.5V
NET3_S_CLKp	HB21_P/E36	Input	Ethernet-3 SGMII 625 MHz Receive Clock	2.5V
NET3_S_CLKn	HB21_N/E37	Input		
NET3_S_TX_p	HA15_P/F16	Output	Ethernet-3 SGMII Transmit Data	2.5V
NET3_S_TX_n	HA15_N/F17	Output		
NET3_S_RX_p	HA16_P/E15	Input	Ethernet-3 SGMII Receive Data	2.5V
NET3_S_RX_n	HA16_N/E16	Input		
NET3_MDC	LA24_N/H29	Output	Ethernet-3 Management Reference Clock	2.5V
NET3_MDIO	LA24_P/H28	Inout	Ethernet-3 Management Data	2.5V
NET3_INT_n	LA25_P/G27	Input	Ethernet-3 Interrupt	2.5V
NET3_LED_LIN K1000	HA06_N/K11	Input	Ethernet-3 Parallel LED output for 1000BASE-T link/speed or link indicator	2.5V
NET3_RST_n	LA25_N/G28	Output	Ethernet-3 Hardware Reset, active low	2.5V

Chapter 4

Example Codes

This chapter provides Nios based examples for users to get started using the NET-FMC board.

4-1 Remote Update Portal

A web server is implemented based on the socket's application program interface (API) provided by the NicheStack TCP/IP Stack Nios II Edition running on a MicroC/OS-II RTOS to serve web content from the TR5 development board. Using DHCP protocol, the web server is able to request a valid IP from the Gateway. The server can process basic requests to serve HTML, JPEG, GIF, PNG, JS, CSS, SWF, ICO files from a single zip file stored onto the flash memory on the TR5 board. User can remote update the web server by rewriting the design files to the flash on the TR5 board.

Figure 4-1 shows the hardware setup of demonstration.

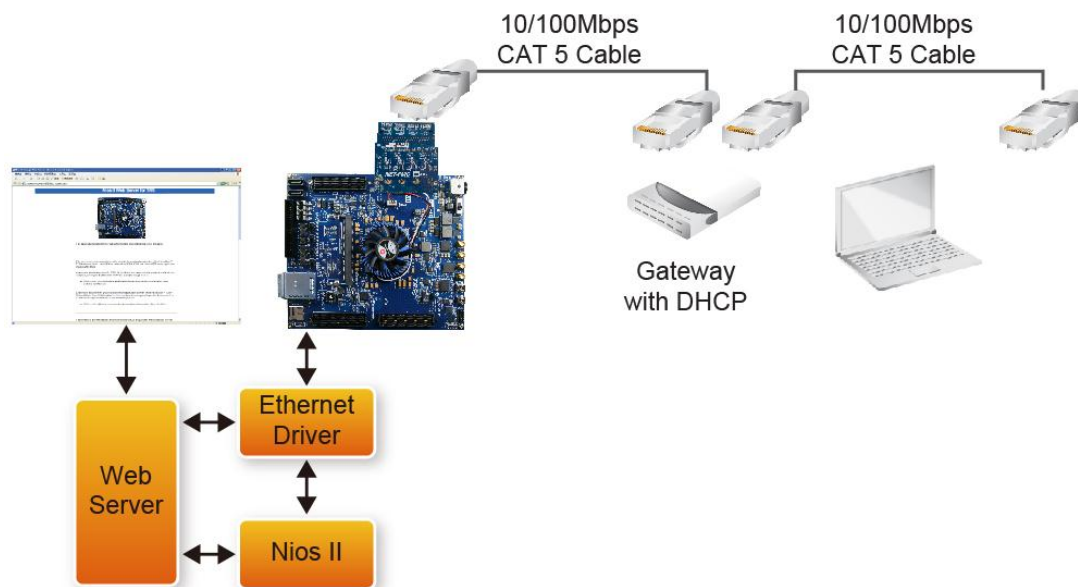

Figure 4-1 hardware setup of remote-update portal demonstration

■ Function block diagram

Figure 4-2 shows the function block diagram of remote-update portal demonstration. Altera Triple Speed Ethernet is configured as 10/100/1000Mb Ethernet MAC with 1000BASE-X/SGMII PCS. A Generic Tri-state Controller(Flash Controller) is configured as a 1Gb Flash controller to connect the off-chip Flash chip. The SGDMA-RX and SGDMA-TX

are used to transmit data between memory and Ethernet. The QSYS system requires one 50MHz clock resource and the Nios II program is resetting from Flash.

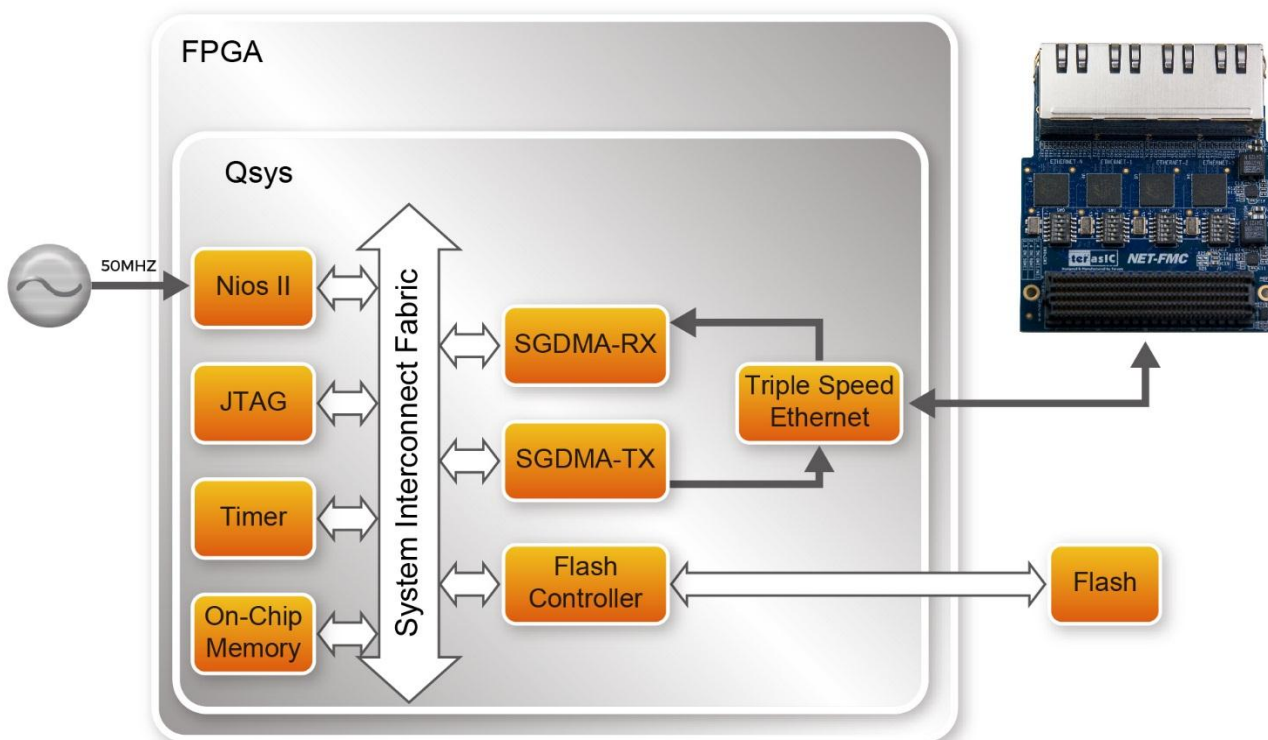

Figure 4-2 Function block diagram of remote-update portal demonstration

Design Tools

- Quartus Prime 16.1
- Nios II Eclipse 16.1

Demonstration Source Code

- Quartus Prime project directory:
TR5_RevC_NET_FMCA_SGMII_update_portal_net0_161
- Nios II Eclipse: TR5_RevC_NET_FMCA_SGMII_update_portal_net0_161\software

Nios Project Compilation

Before you attempt to compile the reference design under Nios II Eclipse, make sure the project is cleaned first by clicking “Clean” from the “Project” menu of Nios II Eclipse.

Demonstration Batch File

Demo Batch File Folder:

TR5_RevC_NET_FMCA_SGMII_update_portal_net0_161\demo_batch

The demo batch file includes following files:

- Batch file for USB-Blaster II: test.bat, test.sh
- FPGA configure file: TR5_golden_top.sof
- Nios II program: web_server.elf

Demonstration Setup

Please follow below procedures to setup the demonstrations.

Generate factory_web_server.pof file

- Make sure Quartus Prime and Nios II are installed on your PC.
- Execute the add_path.bat file in factory_pof directory to add your file location to the .cof file. Or you will meet the error that hex files can not open.
- Open the TR5_RevC_NET_FMCA_SGMII_update_portal_net0_161 project with Quartus software.
- Open the Convert Programming Files window.
- Click the Open Conversion Setup Data button and choose the flash_web_server.cof file in factory_pof directory as shown in **Figure 4-3**.

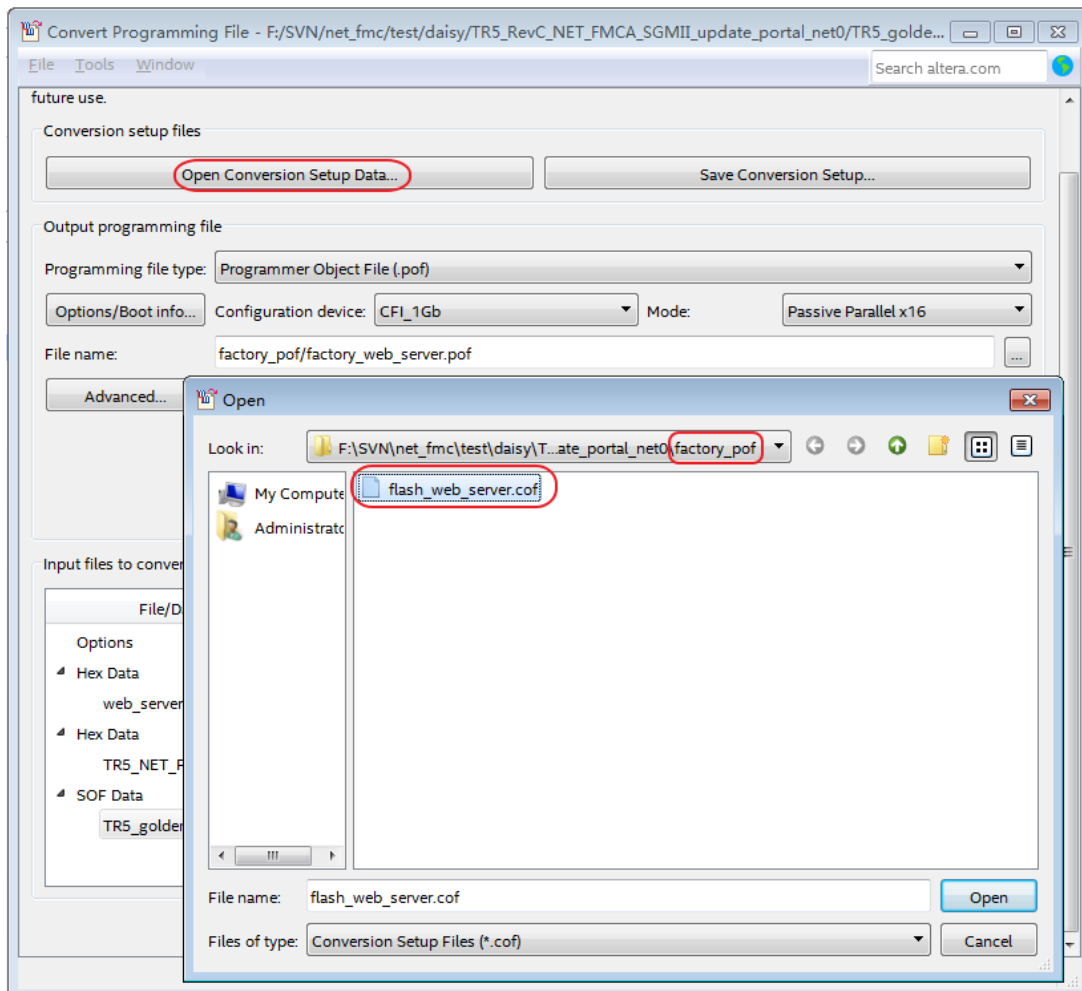

Figure 4-3 Selecting Conversion Setup Data

- Add Sof and Hex Files. The files are added to the convert programmer default when

the .cof file opened as shown in [Figure 4-4](#).

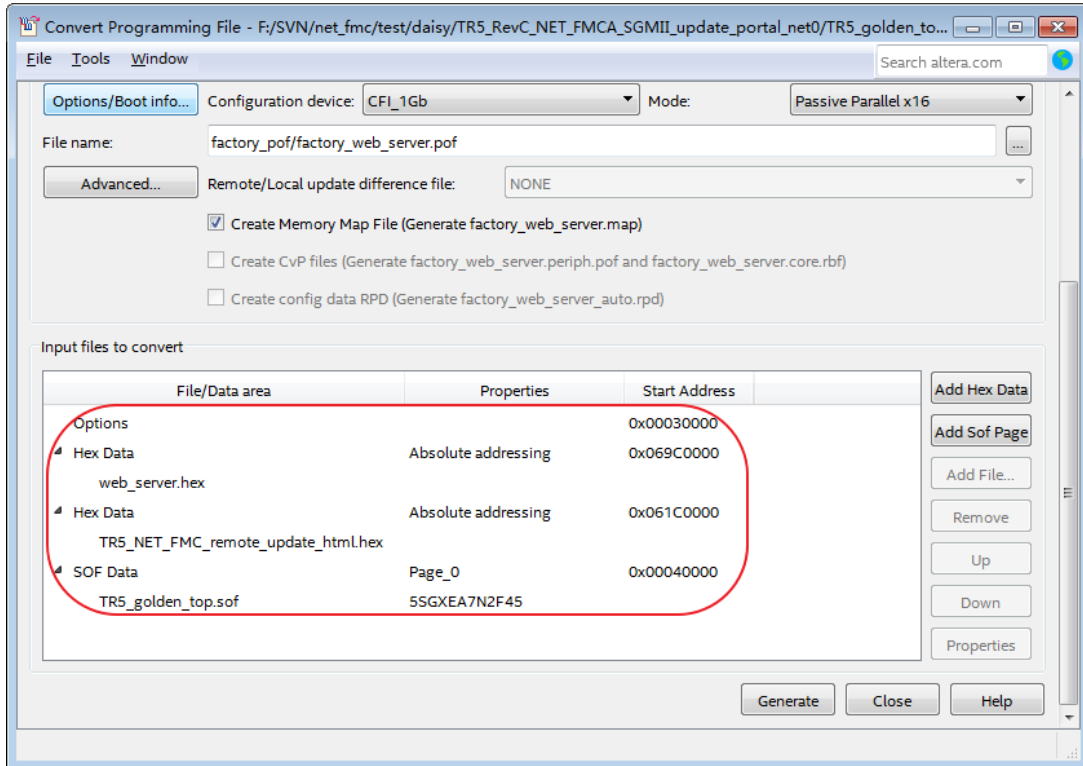

Figure 4-4 adding sof and hex files

- Press Generate button to generate the new factory_web_server.pof in factory_pof directory.

Write the factory_web_server.pof into Flash

- Open Quartus Prime Programmer.
- Connect a Mini USB Cable between the TR5 Board(J6) and the PC.
- Open Hardware Setup window and choose DE5[USB-1] as shown in [Figure 4-5](#).

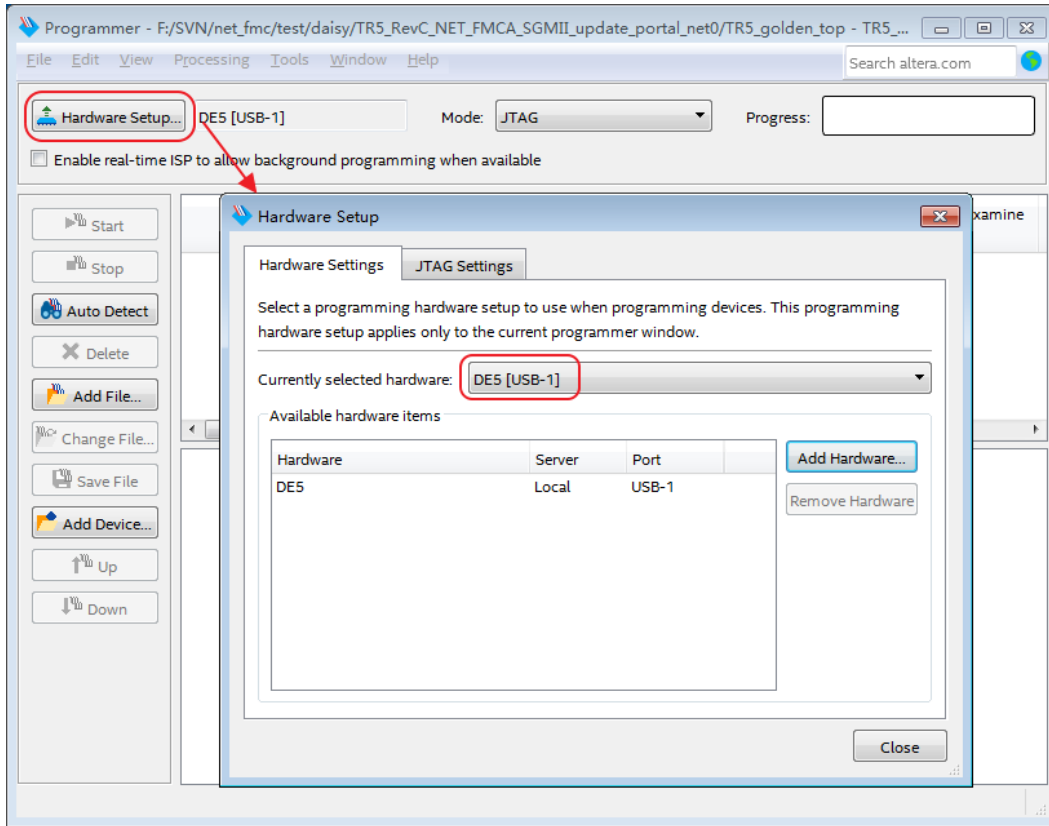

Figure 4-5 Hardware Setup on TR5

- Press add file and choose the TR5_PFL.sof in factory_pof directory.
- Configure the FPGA by pressing Start button.
- Press Auto Detect button after the FPGA configured successfully.
- You will see a CFI_1Gb Flash detected on the JTAG chain. Press Yes to update the device list as shown in **Figure 4-6**.

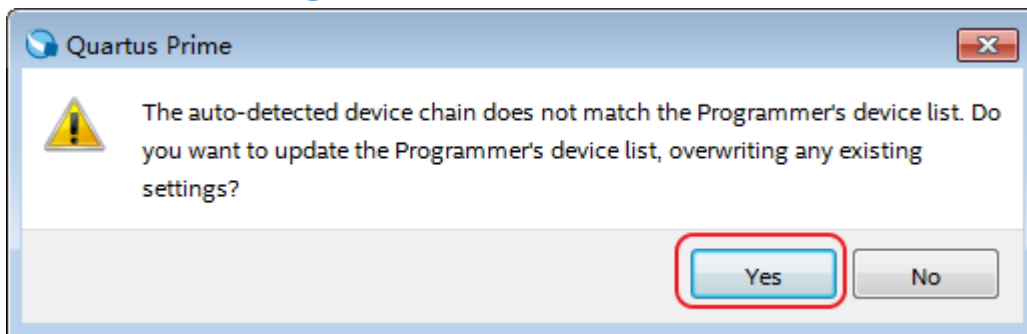

Figure 4-6 Updating the device

- Use the mouse choose the CFI_1Gb device and press Change File button, browse to the factory_pof directory and choose factory_web_server.pof file.
- Check all the files Program and Verify option as in **Figure 4-7** and press Start button to write the Flash.

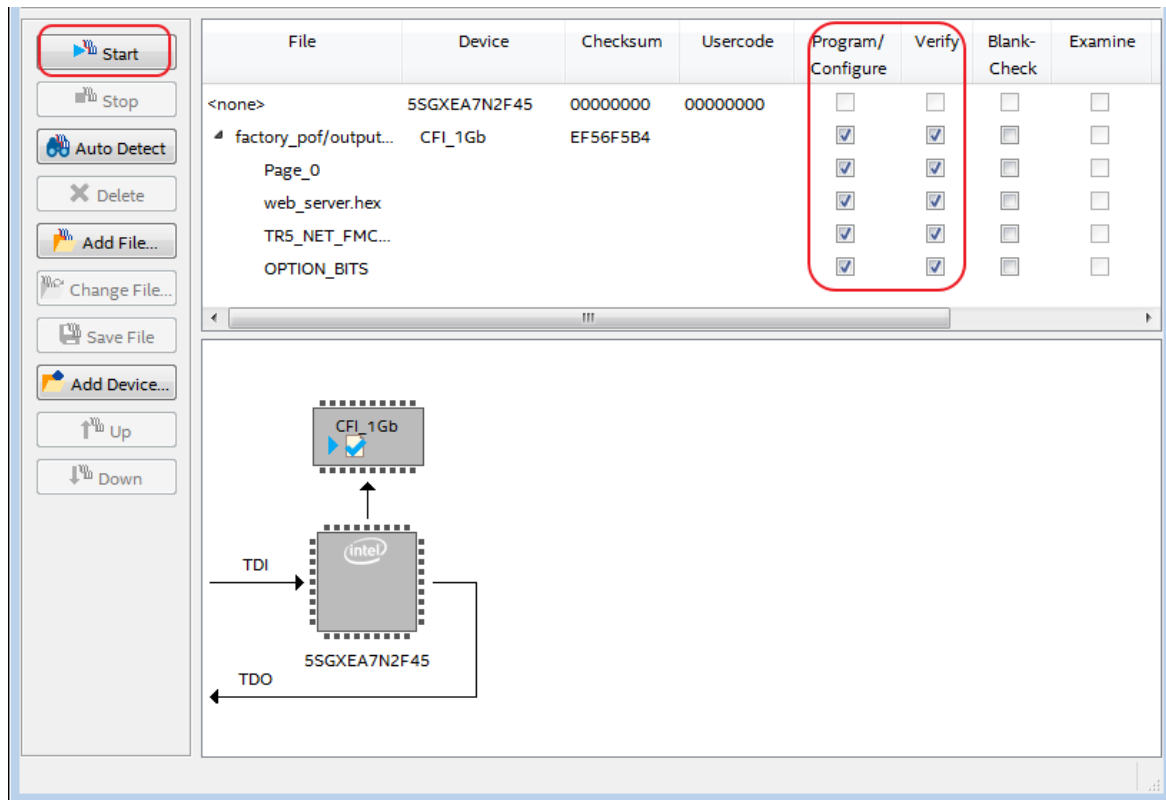
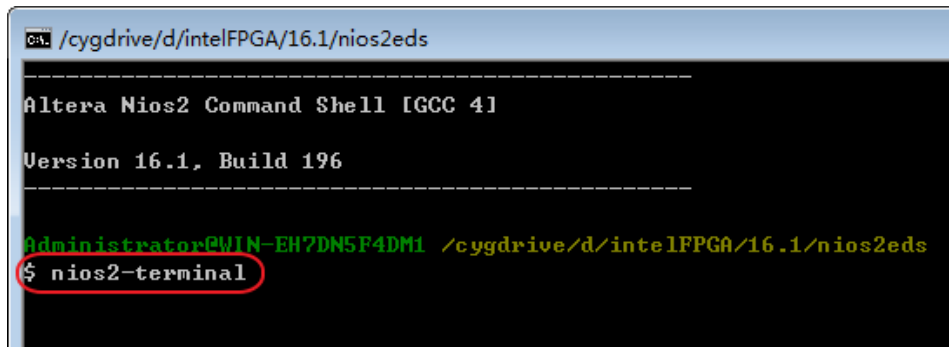

Figure 4-7 Program and Verify Options

- Wait about 10 minutes until the pof file written to the flash successfully, then close the software.

Get the IP address

- Power down the TR5 board.
- Set ETH0 MODE on the NET_FMC card to SGMII mode. The SW0[6:0] on NET-FMC should be set to 010100.
- Connect the RJ45 Ethernet cable to the ETHERNET-0 on NET_FMC daughter card.
- Make sure the VDDJ for FMCA port on TR5 board is 2.5V. The 7&8 Pin of JP5 on TR5 board should be shorted.
- Connect the NET_FMC card on FMCA (J11) port on TR5 mainboard. Please note the demonstration is in FMCA, not in FMCD.
- Set SW4(FACTORY_LOAD) on TR5 mainboard to 0.
- Repower the board.
- Open the nios2-terminal in Nios II Command Shell as shown in Figure 4-8. The command shell is located in the Nios II EDS Installation directory, such as D:\intel\FPGA\16.1\nios2eds.



```
C:\ /cygdrive/d/intelFPGA/16.1/nios2eds
-----
Altera Nios2 Command Shell [GCC 41]
Version 16.1, Build 196
-----
Administrator@WIN-EH7DN5F4DM1 /cygdrive/d/intelFPGA/16.1/nios2eds
$ nios2-terminal
```

Figure 4-8 Open nios2 terminal in Nios II Command Shell

- The first time you open the terminal, the system will request you to type four digital number to generate the MAC address. You can type any 4 digital numbers as shown in [Figure 4-9](#).

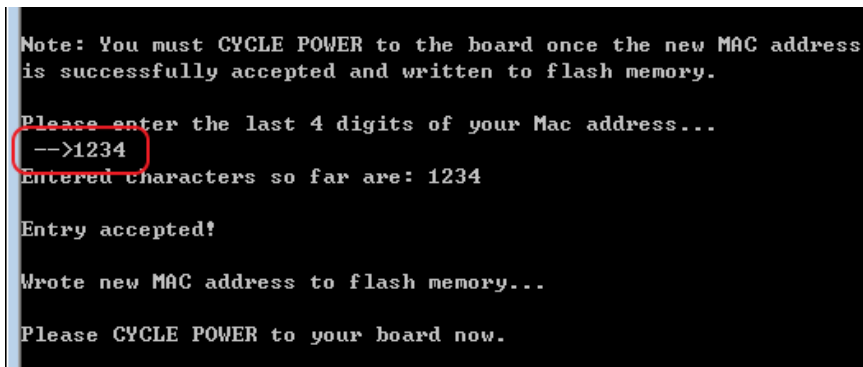

```
Note: You must CYCLE POWER to the board once the new MAC address
is successfully accepted and written to flash memory.

Please enter the last 4 digits of your Mac address...
-->1234
Entered characters so far are: 1234

Entry accepted!

Wrote new MAC address to flash memory...

Please CYCLE POWER to your board now.
```

Figure 4-9 type 4 digital numbers

- Repower the Board again and use the nios2-terminal get the IP address as shown in [Figure 4-10](#). We use the ip address 192.168.21.102 for example.

```

/cygdrive/d/intelFPGA/16.1/nios2eds
prepped 1 interface, initializing...
[tse_mac_init]
INFO : TSE MAC 0 found at address 0x09403000
INFO : PHY Marvell 88E1111 found at PHY address 0x10 of MAC Group[0]
INFO : PHY[0.0] - Automatically mapped to tse_mac_device[0]
INFO : PHY[0.0] - Restart Auto-Negotiation, checking PHY link...
INFO : PHY[0.0] - Auto-Negotiation PASSED
INFO : PCS[0.0] - Configuring PCS operating mode
INFO : PCS[0.0] - PCS SGMII mode disabled
INFO : PHY[0.0] - Checking link...
INFO : PHY[0.0] - Link established
INFO : PHY[0.0] - Speed = 1000, Duplex = Full
OK, x=0, CMD_CONFIG=0x00000000

MAC post-initialization: CMD_CONFIG=0x0400020b
[tse_sgdma_read_init] RX descriptor chain desc (1 depth) created
nctest init called
IP address of et1 : 0.0.0.0
Created "Inet main" task (Prio: 2)
Created "clock tick" task (Prio: 3)
Acquired IP address via DHCP client for interface: et1
IP address : 192.168.21.102
Subnet Mask: 255.255.255.0
Gateway : 192.168.21.1
Created "web server" task (Prio: 11)

```

Figure 4-10 get the ip address

- Type the IP address in your web browser as shown in **Figure 4-11**, then you can access the web content.

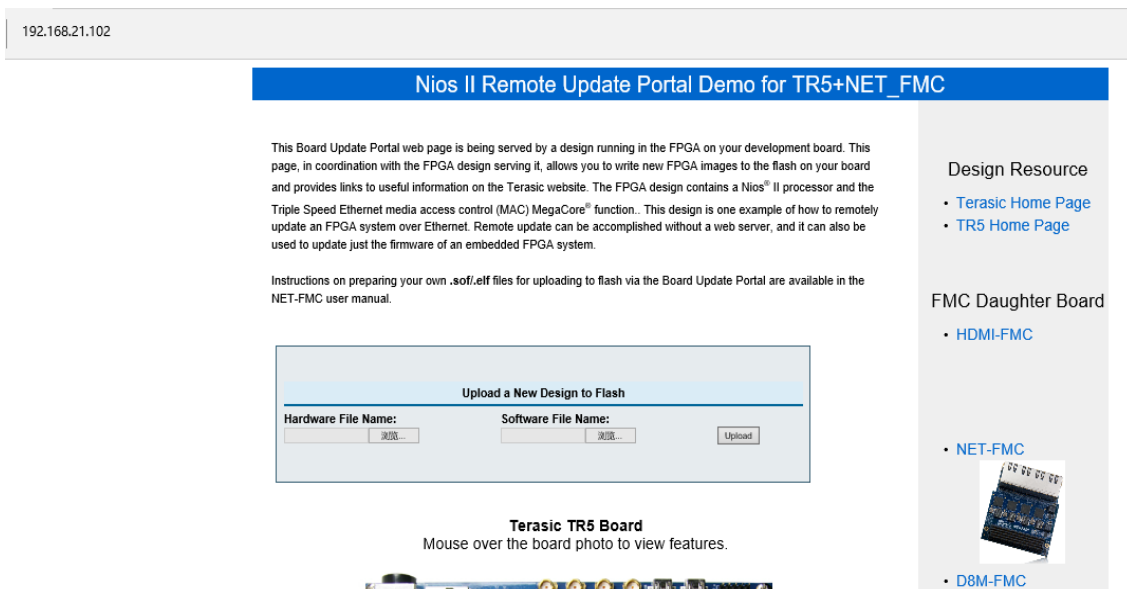

Figure 4-11 access the web content in browser

Remote update your design

- Create your custom Quartus project. If your project contains a nios II system with a

software, you should add a CFI_Flash device on address map 0x00000000 and set the nios2 reset vector to the Flash device. The offset should be 0x071c0000.

- In Nios II Command Shell, convert your custom sof and elf file to flash file with the below commands.

For sof files:

```
sof2flash --input=xxx.sof --output=xxx.flash --offset=0x02940000 --pfl --optionbit=0x00030000
--programmingmode=FPP (the sof file name should be changed according to your quartus project name)
```

For elf file:

```
elf2flash --base=0x00000000 --end=0x07FFFFFF --reset=0x071c0000 --input=xxx.elf --output=xxx.flash
--boot=$SOPC_KIT_NIOS2/components/altera_nios2/boot_loader_cfi.srec (the elf file name should be changed
according to your nios2 software project name)
```

you can use the batch file in flash_convert directory to convert your sof and elf to flash

- In the web page, choose your hardware and software flash files, then press the Upload button to starting write your design files to the Flash on TR5 board.
- The browser will goto the reset_system page when the write process finished.
- Set the FACTORY_LOAD switch (SW4) to 1 and the BOOT_PAGE LED(D24) light on.
- Press the MAX_RST(BUTTON5), the FPGA will be configured with your design.

Chapter 5

Appendix

Revision History

Version	Change Log
V1.0	Initial Version

Copyright Statement

Copyright © 2017 Terasic Inc. All rights reserved.